

Tehničke karakteristike proizvoda

Karakteristike

ZB4BW13

zelena izbočena glava svetlećeg tastera Ø22
sa povratkom za BA9s sijalicu



Osnovne informacije

Grupa proizvoda	Harmony XB4
Tip proizvoda ili komponente	Glava za svetleći taster
Kratko ime uređaja	ZB4
Kompatibilnost proizvoda	BA 9s
Materijal podnožja	Hromirani metal
Tip glave	Standardni
Prečnik za montiranje	22,5 mm
Prodaja po nedeljivim količinama	1
Oblik glave signalne jedinice	Okrugla
Tip glave uređaja	Sa povratkom
Profil glave uređaja	Zelena izbočena, neoznačeno
Dodatne informacije o glavi uređaja	Sa glatkim sočivima
Boja kapica/glave ili sočiva	Zelena

Dopunske informacije

Cad ukupna širina	29 mm
Cad ukupna visina	29 mm
Cad ukupna dubina	32 mm
Masa proizvoda	0,028 kg
Otpornost na uređaj za pranje pod pritiskom	7000000 Pa pri 55 °C, razdaljina : 0.1 m
Mehanička trajnost	10000000 ciklusa
Kod	M7 za <6 kontakti koristeći jednostruke blokove u prednja ugradnja sa BA 9s M8 za <6 kontakti koristeći jednostruke i dvostruke blokove u prednja ugradnja sa BA 9s M9 za <2 kontakti koristeći jednostruke blokove u prednja ugradnja sa BA 9s i transformator
Prezentacija uređaja	Osnovni delovi uređaja

Okruženje

Tretman zaštite	TH
Temperatura okoline za skladištenje	-40...70 °C
Temperatura okoline za rad uređaja	-40...55 °C
Kategorija prenapona	Klasa I u skladu sa IEC 60536
Ip stepen zaštite	IP66 u skladu sa IEC 60529 IP69 IP69K
Nema stepen zaštite	NEMA 13 NEMA 4X
Ik stepen zaštite	IK06 conforming to IEC 62262

Standardi	CSA C22.2 No 14 JIS C8201-5-1 IEC 60947-5-1 IEC 60947-1 IEC 60947-5-5 UL 508 IEC 60947-5-4 JIS C8201-1
Sertifikacija proizvoda	DNV[RETURN]BV[RETURN]UL odobrenje[RETURN]CSA[RETURN]LROS (Lloyds register of shipping)[RETURN]GL
Otpornost na vibracije	5 gn (f= 2...500 Hz) u skladu sa IEC 60068-2-6
Otpornost na udare	30 gn (trajanje = 18 milisekundi) za ubrzanje polovine sinusne periode u skladu sa IEC 60068-2-27 50 gn (trajanje = 11 milisekundi) za ubrzanje polovine sinusne periode u skladu sa IEC 60068-2-27

Pakovanje

Unit Type of Package 1	PCE
Number of Units in Package 1	1
Package 1 Height	4,7 cm
Package 1 Width	3,5 cm
Package 1 Length	5,3 cm
Package 1 Weight	24,0 g
Unit Type of Package 2	S01
Number of Units in Package 2	50
Package 2 Height	15,0 cm
Package 2 Width	15,0 cm
Package 2 Length	40,0 cm
Package 2 Weight	1,605 kg

Održivost ponude

Status održive ponude	Green Premium proizvod
Propis REACH	REACH Deklaracija
REACH bez SVHC	Da
EU RoHS direktiva	Proaktivna usaglašenost (proizvod nije u zakonskom okviru direktive EU RoHS) EU RoHS deklaracija
Bez toksičnih teških metala	Da
Bez žive	Da
RoHS regulativa za Kinu	RoHS Deklaracija Za Kinu
Informacije o RoHS izuzecima	Da
Izjava o zaštiti okoliša	Profil Ekološke Prihvatljivosti Proizvoda
Profil cirkularnosti	Informacije O Kraju Radnog Veka

Ugovorna garancija

Garancija	18 months
-----------	-----------

Dimensions

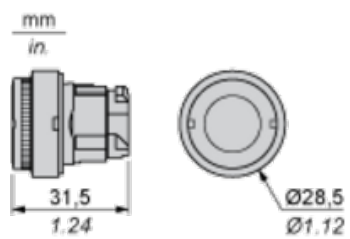

Panel Cut-out for Pushbuttons, Switches and Pilot Lights (Finished Holes, Ready for Installation)

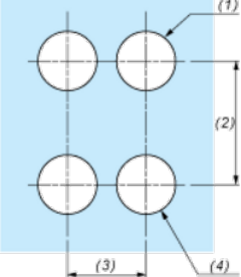
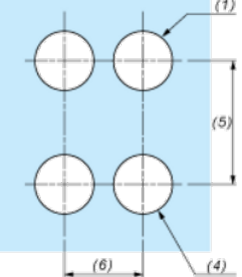
Connection by Screw Clamp Terminals or Plug-in Connectors or on Printed Circuit Board	Connection by Faston Connectors
	
<p>(1) Diameter on finished panel or support (2) 40 mm min. / 1.57 in. min. (3) 30 mm min. / 1.18 in. min. (4) $\varnothing 22.5 \text{ mm} / 0.89 \text{ in.}$ recommended ($\varnothing 22.3 \text{ mm}_0^{+0.4} / 0.88 \text{ in.}_0^{+0.016}$) (5) 45 mm min. / 1.78 in. min. (6) 32 mm min. / 1.26 in. min.</p>	

Pushbuttons, Switches and Pilot Lights for Printed Circuit Board Connection

Panel Cut-outs (Viewed from Installer's Side)



A: 30 mm min. / 1.18 in. min.
 B: 40 mm min. / 1.57 in. min.

Printed Circuit Board Cut-outs (Viewed from Electrical Block Side)

Dimensions in mm

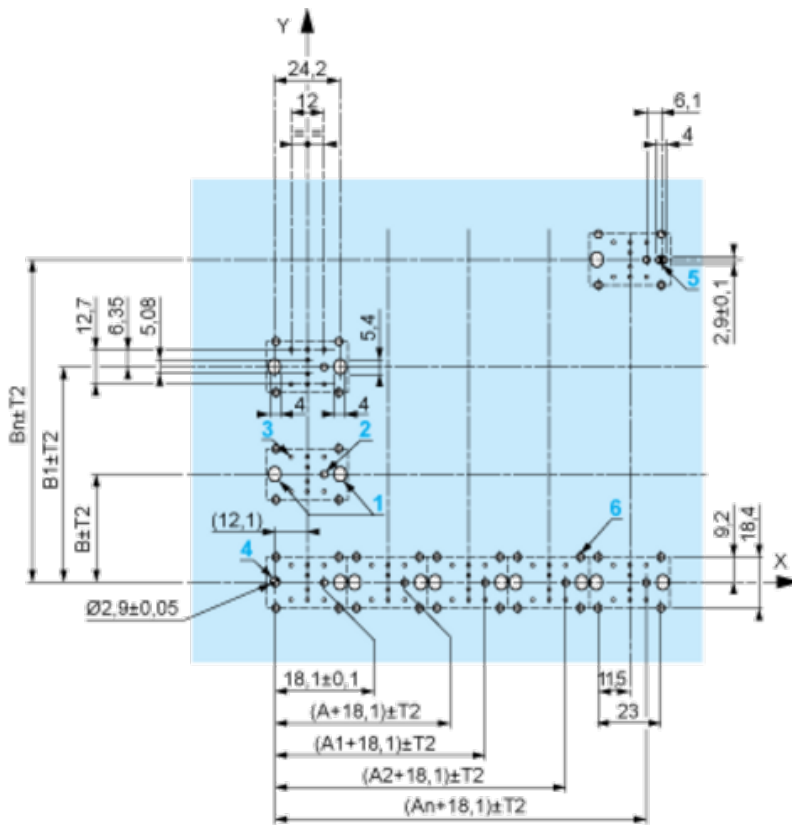

A: 30 mm min.
 B: 40 mm min.
 Dimensions in in.

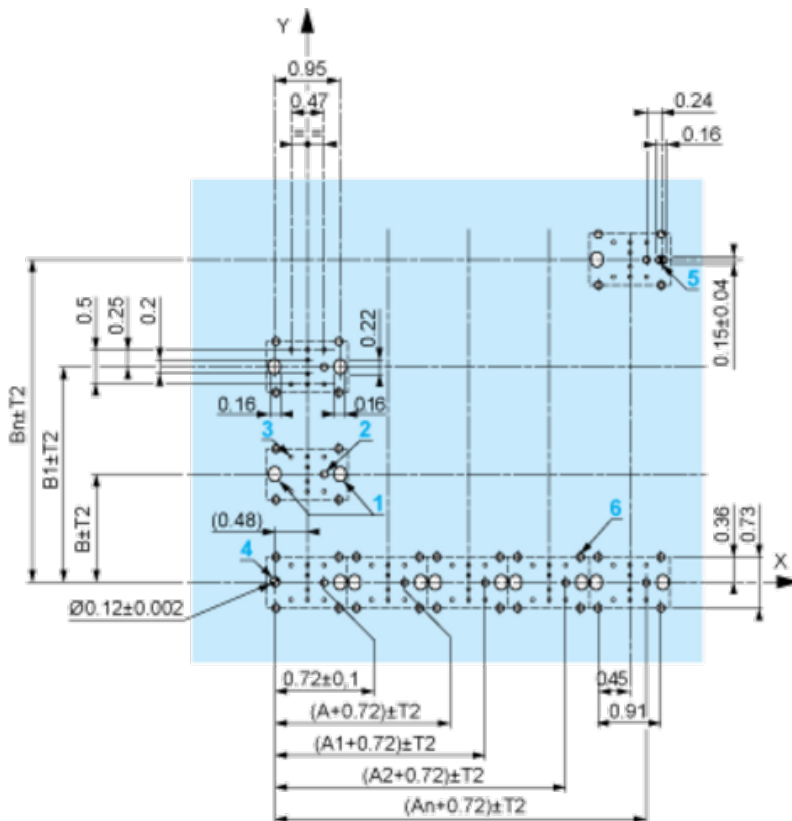

A: 1.18 in. min.
 B: 1.57 in. min.

General Tolerances of the Panel and Printed Circuit Board

The cumulative tolerance must not exceed 0.3 mm / 0.012 in: T1 + T2 = 0.3 mm max.

Installation Precautions

- Minimum thickness of circuit board: 1.6 mm / 0.06 in.
- Cut-out diameter: 22.4 mm ± 0.1 / 0.88 in. ± 0.004
- Orientation of body/fixing collar ZB4 BZ009: ± 2°30' (excluding cut-outs marked a and b).
- Tightening torque of screws ZBZ 006: 0.6 N.m (5.3 lbf.in) max.
- Allow for one ZB4 BZ079 fixing collar/pillar and its fixing screws:
 - every 90 mm / 3.54 in. horizontally (X), and 120 mm / 4.72 in. vertically (Y).
 - with each selector switch head (ZB4 BD•, ZB4 BJ•, ZB4 BG•).

The fixing centers marked a and b are diagonally opposed and must align with those marked 4 and 5.

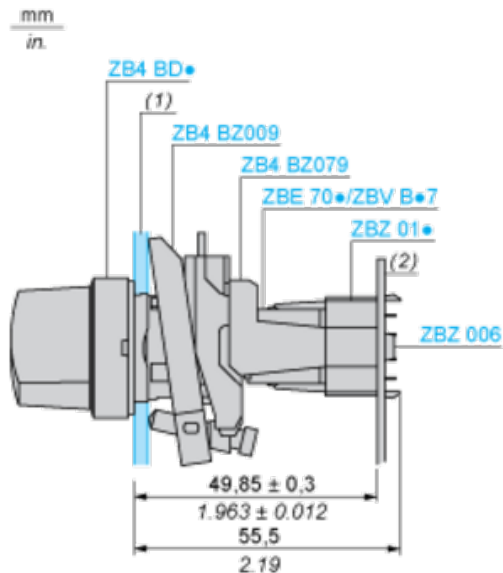

(1) Panel

(2) Printed circuit board

Mounting of Adapter (Socket) ZBZ 01•

- 1 2 elongated holes for ZBZ 006 screw access
- 2 1 hole Ø 2.4 mm ± 0.05 / 0.09 in. ± 0.002 for centring adapter ZBZ 01•
- 3 8 × Ø 1.2 mm / 0.05 in. holes
- 4 1 hole Ø 2.9 mm ± 0.05 / 0.11 in. ± 0.002, for aligning the printed circuit board (with cut-out marked a)
- 5 1 elongated hole for aligning the printed circuit board (with cut-out marked b)
- 6 4 holes Ø 2.4 mm / 0.09 in. for clipping in adapter ZBZ 01•

Dimensions An + 18.1 relate to the Ø 2.4 mm ± 0.05 / 0.09 in. ± 0.002 holes for centring adapter ZBZ 01•.

Electrical Composition Corresponding to Codes M1 and M7

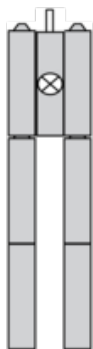

Electrical Composition Corresponding to Codes M2 and M8



Electrical Composition Corresponding to Code M9

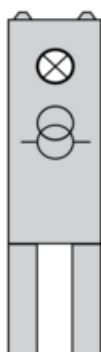

Legend

Single contact

Double contact

Light block

Possible location

