

## Tehničke karakteristike proizvoda

### Karakteristike

## ZB4BK1463

plava svetleća glava izbornog prekidača Ø22 2-  
pozicije sa povratkom



### Osnovne informacije

Grupa proizvoda	Harmony XB4
Tip proizvoda ili komponente	Glava za svetleći izborni prekidač
Kompatibilnost proizvoda	Universal LED
Kratko ime uređaja	ZB4
Materijal podnožja	Hromirani metal
Tip glave	Standardni
Prečnik za montiranje	22,5 mm
Prodaja po nedeljivim količinama	1
Oblik glave signalne jedinice	Okrugla
Tip glave uređaja	Desno ka levoj poziciji sa povratkom
Profil glave uređaja	Plava standardna ručica
Informacija o poziciji glave	2 pozicije 90°
Boja kapica/glave ili sočiva	Plava

### Dopunske informacije

Cad ukupna širina	29 mm
Cad ukupna visina	29 mm
Cad ukupna dubina	43 mm
Masa proizvoda	0,037 kg
Otpornost na uređaj za pranje pod pritiskom	7000000 Pa pri 55 °C, razdaljina : 0.1 m
Mehanička trajnost	500000 ciklusa
Kod	M3 za <4 kontakti koristeći jednostruke blokove u prednja ugradnja sa integrisan LED M6 za <2 kontakti koristeći jednostruke blokove u prednja ugradnja sa integrisan LED i transformator M10 za <2 kontakti koristeći jednostruke blokove u prednja ugradnja sa integrisan LED M4 za <4 kontakti koristeći jednostruke i dvostruke blokove u prednja ugradnja sa integrisan LED
Prezentacija uređaja	Osnovni element

### Okruženje

Tretman zaštite	TH
Temperatura okoline za skladištenje	-40...70 °C
Temperatura okoline za rad uređaja	-40...70 °C
Kategorija prenapona	Klasa I u skladu sa IEC 60536
Ip stepen zaštite	IP66 u skladu sa IEC 60529 IP67 IP69 IP69K
Nema stepen zaštite	NEMA 13 NEMA 4X

Ik stepen zaštite	IK04 conforming to IEC 50102
Standardi	CSA C22.2 No 14 IEC 60947-5-1 UL 508 JIS C8201-5-1 IEC 60947-5-5 IEC 60947-1 IEC 60947-5-4 JIS C8201-1
Sertifikacija proizvoda	DNV[RETURN]LROS (Lloyds register of shipping) [RETURN]BV[RETURN]GL[RETURN]CSA[RETURN]UL odobrenje
Otpornost na vibracije	5 gn (f= 2...500 Hz) u skladu sa IEC 60068-2-6
Otpornost na udare	30 gn (trajanje = 18 milisekundi) za ubrzanje polovine sinusne periode u skladu sa IEC 60068-2-27 50 gn (trajanje = 11 milisekundi) za ubrzanje polovine sinusne periode u skladu sa IEC 60068-2-27

## Pakovanje

Unit Type of Package 1	PCE
Number of Units in Package 1	1
Package 1 Height	8,8 cm
Package 1 Width	3,4 cm
Package 1 Length	5,4 cm
Package 1 Weight	80 g
Unit Type of Package 2	BB1
Number of Units in Package 2	10
Package 2 Height	7 cm
Package 2 Width	26,5 cm
Package 2 Length	100 cm
Package 2 Weight	800 g
Unit Type of Package 3	S01
Number of Units in Package 3	50
Package 3 Height	15 cm
Package 3 Width	15 cm
Package 3 Length	40 cm
Package 3 Weight	2,275 kg

## Održivost ponude

Status održive ponude	Green Premium proizvod
Propis REACh	<a href="#">REACh Deklaracija</a>
REACh bez SVHC	Da
EU RoHS direktiva	Proaktivna usaglašenost (proizvod nije u zakonskom okviru direktive EU RoHS) <a href="#">EU RoHS deklaracija</a>
Bez toksičnih teških metala	Da
Bez žive	Da
RoHS regulativa za Kinu	<a href="#">RoHS Deklaracija Za Kinu</a>
Informacije o RoHS izuzecima	<a href="#">Da</a>
Izjava o zaštiti okoliša	<a href="#">Profil Ekološke Prihvatljivosti Proizvoda</a>
Profil cirkularnosti	<a href="#">Informacije O Kraju Radnog Veka</a>

## Ugovorna garancija

Garancija	18 months
-----------	-----------

---

Dimensions

---

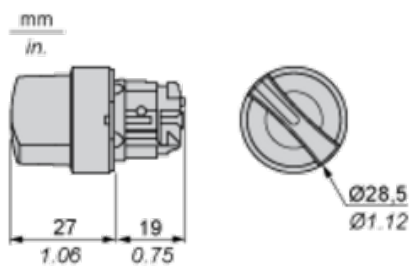

Panel Cut-out for Pushbuttons, Switches and Pilot Lights (Finished Holes, Ready for Installation)

Connection by Screw Clamp Terminals or Plug-in Connectors or on Printed Circuit Board	Connection by Faston Connectors
<p>(1) Diameter on finished panel or support                  (2) 40 mm min. / 1.57 in. min.                  (3) 30 mm min. / 1.18 in. min.                  (4) <math>\varnothing 22.5 \text{ mm} / 0.89 \text{ in.}</math> recommended (<math>\varnothing 22.3 \text{ mm}_0^{+0.4} / 0.88 \text{ in.}_0^{+0.016}</math>)                  (5) 45 mm min. / 1.78 in. min.                  (6) 32 mm min. / 1.26 in. min.</p>	

Pushbuttons, Switches and Pilot Lights for Printed Circuit Board Connection

Panel Cut-outs (Viewed from Installer's Side)

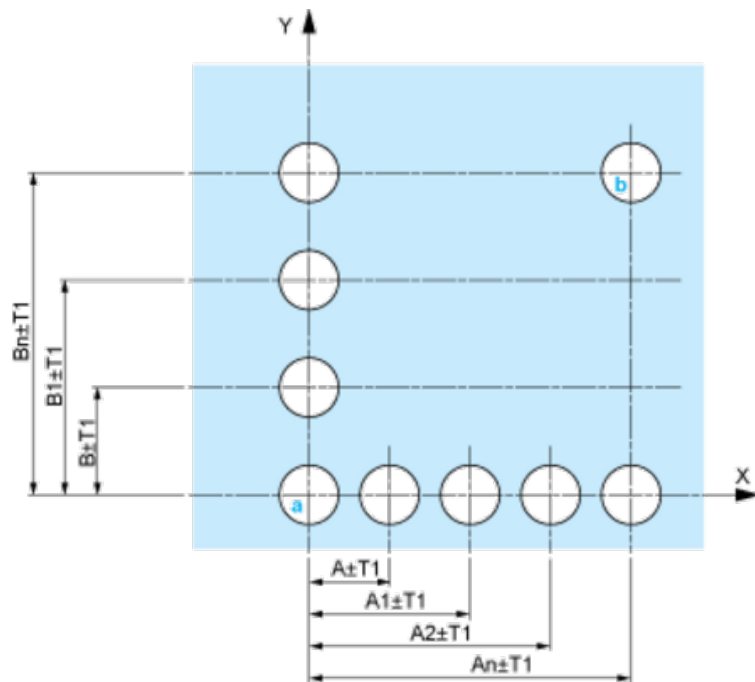

A: 30 mm min. / 1.18 in. min.  
 B: 40 mm min. / 1.57 in. min.

Printed Circuit Board Cut-outs (Viewed from Electrical Block Side)

Dimensions in mm

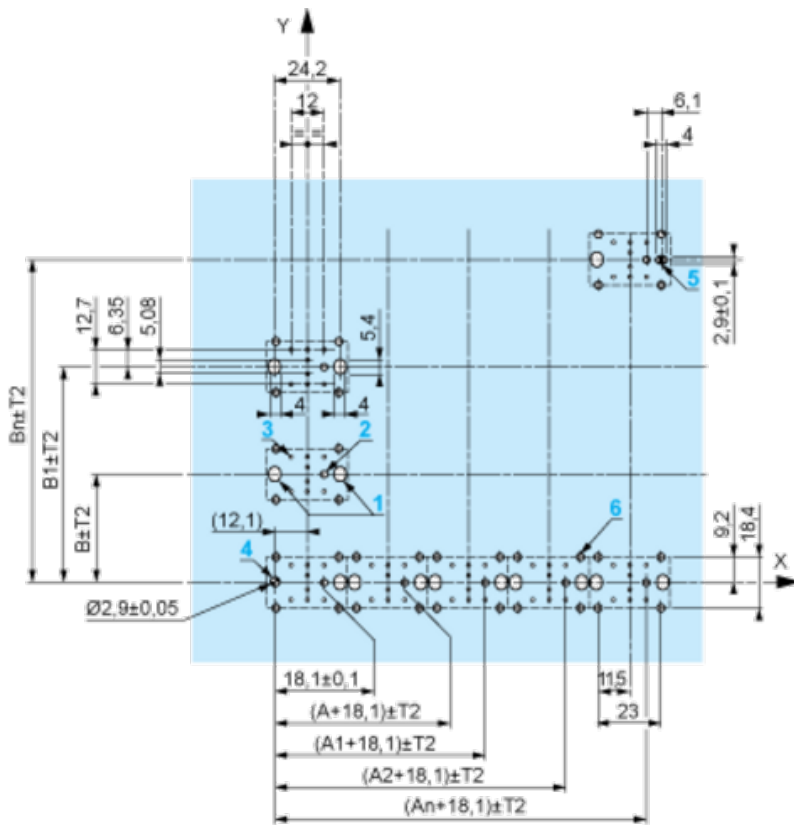

A: 30 mm min.  
 B: 40 mm min.  
 Dimensions in in.

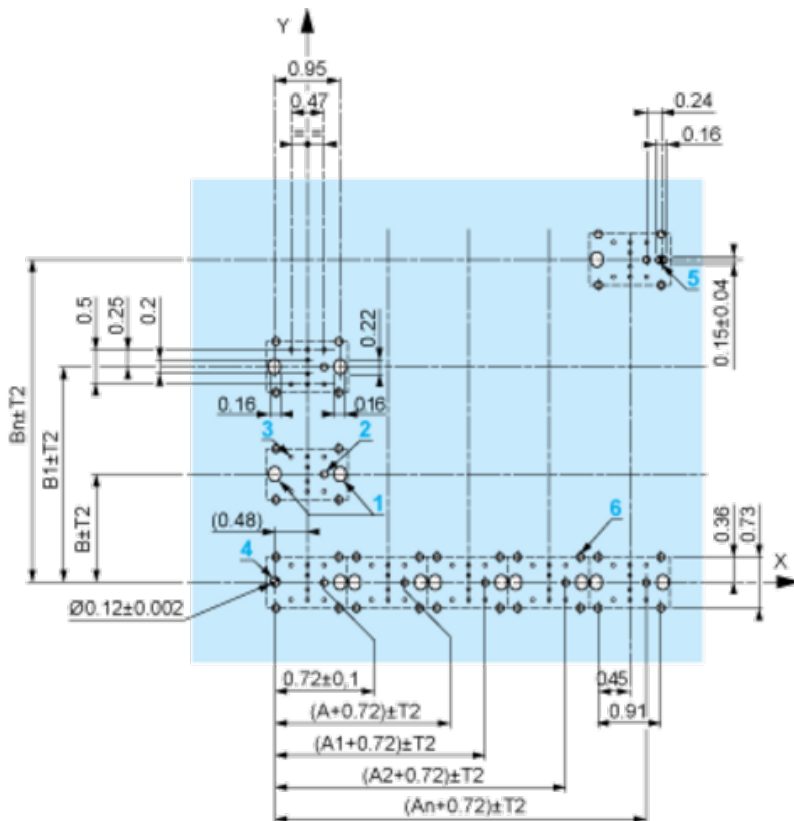

A: 1.18 in. min.  
 B: 1.57 in. min.

### General Tolerances of the Panel and Printed Circuit Board

The cumulative tolerance must not exceed 0.3 mm / 0.012 in:  $T1 + T2 = 0.3$  mm max.

## Installation Precautions

- Minimum thickness of circuit board: 1.6 mm / 0.06 in.
- Cut-out diameter: 22.4 mm ± 0.1 / 0.88 in. ± 0.004
- Orientation of body/fixing collar ZB4 BZ009: ± 2°30' (excluding cut-outs marked a and b).
- Tightening torque of screws ZBZ 006: 0.6 N.m (5.3 lbf.in) max.
- Allow for one ZB4 BZ079 fixing collar/pillar and its fixing screws:
  - every 90 mm / 3.54 in. horizontally (X), and 120 mm / 4.72 in. vertically (Y).
  - with each selector switch head (ZB4 BD•, ZB4 BJ•, ZB4 BG•).

The fixing centers marked a and b are diagonally opposed and must align with those marked 4 and 5.

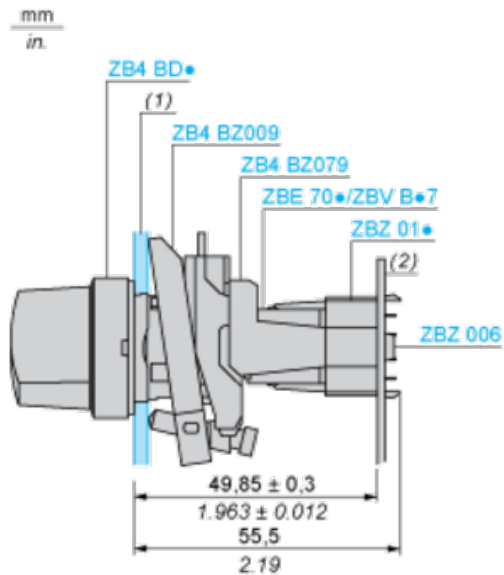

(1) Panel

(2) Printed circuit board

## Mounting of Adapter (Socket) ZBZ 01•

- 1 2 elongated holes for ZBZ 006 screw access
- 2 1 hole Ø 2.4 mm ± 0.05 / 0.09 in. ± 0.002 for centring adapter ZBZ 01•
- 3 8 × Ø 1.2 mm / 0.05 in. holes
- 4 1 hole Ø 2.9 mm ± 0.05 / 0.11 in. ± 0.002, for aligning the printed circuit board (with cut-out marked a)
- 5 1 elongated hole for aligning the printed circuit board (with cut-out marked b)
- 6 4 holes Ø 2.4 mm / 0.09 in. for clipping in adapter ZBZ 01•

Dimensions An + 18.1 relate to the Ø 2.4 mm ± 0.05 / 0.09 in. ± 0.002 holes for centring adapter ZBZ 01•.

---

Electrical Composition Corresponding to Code M3

---

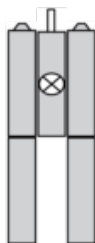

---

Electrical Composition Corresponding to Code M4

---

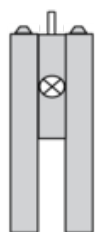

---

Electrical Composition Corresponding to Codes M6 and P2

---

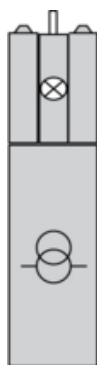

---

Electrical Composition Corresponding to Codes M5, M10, MF1, MR1 and MF2

---

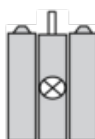

---

Legend

---

Single contact

Double contact

Light block





Possible location



### Sequence of Contacts Fitted to 2-position Selector Switch Body

#### Position 315°



Push	Position	Top			
Bottom					
Location		Left	Right		
State		0	0		
Contacts	N/O		open	open	
N/C		closed	closed		

#### Position 45°



Push	Position	Top			
Bottom	<input type="checkbox"/>	<input type="checkbox"/>			
Location		Left	Right		
State		1	1		
Contacts	N/O		closed	closed	
N/C		open	open		