

Tehničke karakteristike proizvoda

Karakteristike

ZB4BG612

glava izbornog prekidača Ø22 2-pozicije
opružni sa povratkom Ronis 421E



Osnovne informacije

Grupa proizvoda	Harmony XB4
Tip proizvoda ili komponente	Glava za izborni prekidač sa ključem
Kratko ime uređaja	ZB4
Materijal podnožja	Hromirani metal
Prečnik za montiranje	22 mm
Tip glave	Standardni
Prodaja po nedeljivim količinama	1
Oblik glave signalne jedinice	Okrugla
Povratak	Desno ka levoj poziciji
Profil glave uređaja	Crna ključ taster
Tip ručice	Sa povratkom
Informacija o poziciji glave	2 pozicije 90°
Tip brave	Key 421E
Pozicija vađenja ključa	Levo

Dopunske informacije

Čad ukupna širina	29 mm
Čad ukupna visina	29 mm
Čad ukupna dubina	72 mm
Masa proizvoda	0,098 kg
Otpornost na uređaj za pranje pod pritiskom	7000000 Pa pri 55 °C, razdaljina : 0.1 m
Mehanička trajnost	1000000 ciklusa
Kod	C3 za <6 kontakti koristeći jednostruke blokove u prednja ugradnja C4 za <6 kontakti koristeći jednostruke i dvostruke blokove u prednja ugradnja C5 za <5 kontakti koristeći jednostruke blokove u prednja ugradnja C6 za <5 kontakti koristeći jednostruke i dvostruke blokove u prednja ugradnja C7 za <4 kontakti koristeći jednostruke blokove u prednja ugradnja C8 za <4 kontakti koristeći jednostruke i dvostruke blokove u prednja ugradnja C11 za <3 kontakti koristeći jednostruke blokove u prednja ugradnja C15 za <1 kontakti koristeći jednostruke blokove u prednja ugradnja
Prezentacija uređaja	Osnovni element

Okruženje

Tretman zaštite	TH
Temperatura okoline za skladištenje	-40...70 °C
Temperatura okoline za rad uređaja	-40...70 °C
Kategorija prenapona	Klasa I u skladu sa IEC 60536
Ip stepen zaštite	IP66 u skladu sa IEC 60529 IP67 IP69 IP69K
Nema stepen zaštite	NEMA 13 NEMA 4X

Standardi	UL 508 GB 14048.5 EN/IEC 60947-5-5 EN/IEC 60947-5-4 EN/IEC 60947-5-1 EN/IEC 60947-1 CSA C22.2 No 14
Sertifikacija proizvoda	DNV[RETURN]LROS (Lloyds register of shipping) [RETURN]GL[RETURN]CSA[RETURN]BV[RETURN]UL odobrenje
Otpornost na vibracije	5 gn (f= 2...500 Hz) u skladu sa IEC 60068-2-6
Otpornost na udare	30 gn (trajanje = 18 milisekundi) za ubrzanje polovine sinusne periode u skladu sa IEC 60068-2-27 50 gn (trajanje = 11 milisekundi) za ubrzanje polovine sinusne periode u skladu sa IEC 60068-2-27

Pakovanje

Unit Type of Package 1	PCE
Number of Units in Package 1	1
Package 1 Height	3,4 cm
Package 1 Width	5,4 cm
Package 1 Length	9,1 cm
Package 1 Weight	103 g
Unit Type of Package 2	S03
Number of Units in Package 2	100
Package 2 Height	30 cm
Package 2 Width	30 cm
Package 2 Length	40 cm
Package 2 Weight	10,749 kg

Održivost ponude

Status održive ponude	Green Premium proizvod
Propis REACH	REACH Deklaracija
EU RoHS direktiva	Proaktivna usaglašenost (proizvod nije u zakonskom okviru direktive EU RoHS)
Bez žive	Da
RoHS regulativa za Kinu	RoHS Deklaracija Za Kinu
Informacije o RoHS izuzecima	Da
Izjava o zaštiti okoliša	Profil Ekološke Prihvatljivosti Proizvoda
Profil cirkularnosti	Informacije O Kraju Radnog Veka

Ugovorna garancija

Garancija	18 months
-----------	-----------

Dimensions

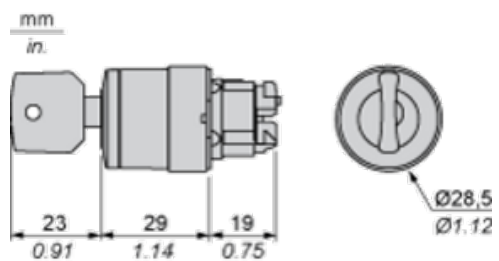

Panel Cut-out for Pushbuttons, Switches and Pilot Lights (Finished Holes, Ready for Installation)

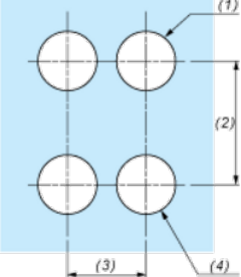
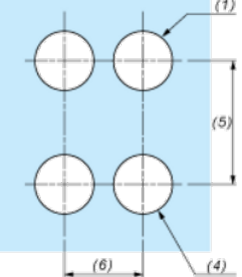
Connection by Screw Clamp Terminals or Plug-in Connectors or on Printed Circuit Board	Connection by Faston Connectors
	
<p>(1) Diameter on finished panel or support (2) 40 mm min. / 1.57 in. min. (3) 30 mm min. / 1.18 in. min. (4) $\varnothing 22.5 \text{ mm} / 0.89 \text{ in.}$ recommended ($\varnothing 22.3 \text{ mm}_0^{+0.4} / 0.88 \text{ in.}_0^{+0.016}$) (5) 45 mm min. / 1.78 in. min. (6) 32 mm min. / 1.26 in. min.</p>	

Pushbuttons, Switches and Pilot Lights for Printed Circuit Board Connection

Panel Cut-outs (Viewed from Installer's Side)



A: 30 mm min. / 1.18 in. min.
 B: 40 mm min. / 1.57 in. min.

Printed Circuit Board Cut-outs (Viewed from Electrical Block Side)

Dimensions in mm



A: 30 mm min.
 B: 40 mm min.
 Dimensions in in.



A: 1.18 in. min.
 B: 1.57 in. min.

General Tolerances of the Panel and Printed Circuit Board

The cumulative tolerance must not exceed 0.3 mm / 0.012 in: T1 + T2 = 0.3 mm max.

Installation Precautions

- Minimum thickness of circuit board: 1.6 mm / 0.06 in.
- Cut-out diameter: 22.4 mm \pm 0.1 / 0.88 in. \pm 0.004
- Orientation of body/fixing collar ZB4 BZ009: $\pm 2^\circ 30'$ (excluding cut-outs marked a and b).
- Tightening torque of screws ZBZ 006: 0.6 N.m (5.3 lbf.in) max.
- Allow for one ZB4 BZ079 fixing collar/pillar and its fixing screws:
 - every 90 mm / 3.54 in. horizontally (X), and 120 mm / 4.72 in. vertically (Y).
 - with each selector switch head (ZB4 BD•, ZB4 BJ•, ZB4 BG•).

The fixing centers marked a and b are diagonally opposed and must align with those marked 4 and 5.

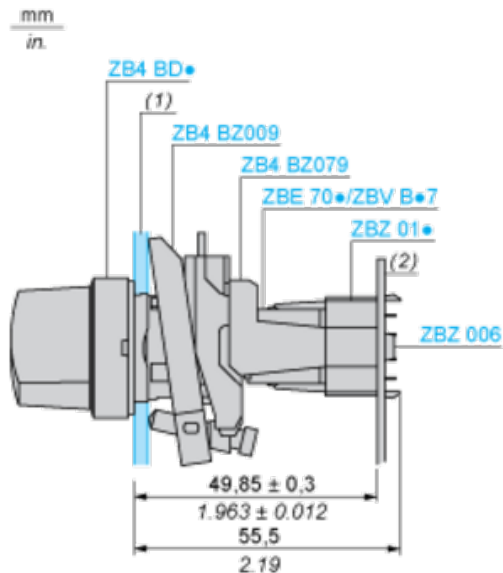

(1) Panel

(2) Printed circuit board

Mounting of Adapter (Socket) ZBZ 01•

- 1 2 elongated holes for ZBZ 006 screw access
- 2 1 hole \varnothing 2.4 mm \pm 0.05 / 0.09 in. \pm 0.002 for centring adapter ZBZ 01•
- 3 8 \times \varnothing 1.2 mm / 0.05 in. holes
- 4 1 hole \varnothing 2.9 mm \pm 0.05 / 0.11 in. \pm 0.002, for aligning the printed circuit board (with cut-out marked a)
- 5 1 elongated hole for aligning the printed circuit board (with cut-out marked b)
- 6 4 holes \varnothing 2.4 mm / 0.09 in. for clipping in adapter ZBZ 01•

Dimensions An + 18.1 relate to the \varnothing 2.4 mm \pm 0.05 / 0.09 in. \pm 0.002 holes for centring adapter ZBZ 01•.

Electrical Composition Corresponding to Code C3



Electrical Composition Corresponding to Code C4

Electrical Composition Corresponding to Code C5

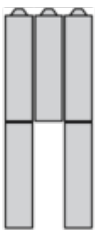

Electrical Composition Corresponding to Code C6

Electrical Composition Corresponding to Code C7

Electrical Composition Corresponding to Code C8

Electrical Composition Corresponding to Codes C9, C11, SF1 and SR1

Electrical Composition Corresponding to Code C15

1 N/O

1 N/C

1 N/O + N/C or 1 N/O + N/O or 1 N/C + N/C

Legend

Single contact

Double contact

Light block





Possible location



Sequence of Contacts Fitted to 2-position Selector Switch Body

Position 315°



Push	Position	Top			
Bottom					
Location		Left	Centre	Right	
State		0	0	0	
Contacts	N/O		open	open	open
N/C		closed	closed	closed	

Position 45°



Push	Position	Top			
Bottom					
Location		Left	Centre	Right	
State		1	1	1	
Contacts	N/O		closed	closed	closed
N/C		open	open	open	