

# Lista sa podacima o proizvodima

Specifikacije



Kompletni selektorski prekidač,  
Easy Harmony XA2, plastična duga  
ručica, 22mm, 3 pozicije, 2NO, fiksni  
položaj, crna

XA2AJ33

## Osnovne informacije

Grupa proizvoda	Easy Harmony XA2
Kratko ime uređaja	XA2
Tip proizvoda ili komponente	Kompletni izborni prekidač
Prezentacija uređaja	Kompletnan proizvod
Ime komponente	XA2A
Materijal podnožja	Plastika
Materijal montažnog rama	Plastika
Prečnik za montiranje	22,5 mm

## Dopunske informacije

Prodaja po nedeljivim količinama	1
Centar za fiksiranje	$\geq 30 \times 40$ mm (panel) 1...5 mm
Način fiksiranja	Maticom za fiksiranje: 2...2,4 N.m
Oblik glave signalne jedinice	Okrugla
Profil glave uređaja	Crna duga ručica (bela)
Informacija o poziciji glave	3 pozicije 45°
Tip kontakata i sastav	2 NO
Operacija kontakata	Sporo isključenje
Mehanička trajnost	300000 ciklusa
povezivanje - priključci	Vijčani priključni blok, kapacitet stezaljke: $\leq 2 \times 1,5$ mm <sup>2</sup> Vijčani priključni blok, kapacitet stezaljke: $\leq 1 \times 2,5$ mm <sup>2</sup> Vijčani priključni blok, kapacitet stezaljke: $\geq 1 \times 0,5$ mm <sup>2</sup> Faston priključci 6.3 mm
Moment pritezanja	0,8...1,2 N.m
Zaštita od kratkog spoja	10 A osigurač tip GL u skladu sa IEC 60269-1
[I <sub>th</sub> ] dozvoljena termička struja u vazduhu	10 A (vijčani priključni blokovi)
[u <sub>i</sub> ] nazivni napon izolacije	600 V u skladu sa IEC 60947-1
[u <sub>imp</sub> ] nazivni podnosivi impulsni napon	6 kV u skladu sa IEC 60947-1
[i <sub>e</sub> ] nazivna radna struja	3 A pri 240 V, AC-15, A600 0,27 A pri 250 V, DC-13, Q600
Električna trajnost	500000 ciklusa, AC-15, 3 A pri 230 V, broj operacija <60 ciklusa/min, faktor opterećenja: 0,5 u skladu sa IEC 60947-5-1 500000 ciklusa, DC-13, 0,2 A pri 110 V, broj operacija <60 ciklusa/min, faktor opterećenja: 0,5 u skladu sa IEC 60947-5-1

### Električna pouzdanost iec

60947-5-1 koje su navedene u ovom cenovniku su informativne i neobavezujuće, bez PDV-a, isključivo u odnosu na ovlašćene distributere kompanije Schneider Electric. Svi prikazi, opisi i tehničke specifikacije i podaci u ovom cenovniku su podložni promenama od strane kompanije Schneider Electric bez prethodne najave.

Širina	30,0 mm
Visina	43,0 mm
Dubina	70,0 mm
masa proizvoda	0,055 kg
Tip ručice	Bez povratka
Tip glave	Standardni
Boja kapica/glave ili sočiva	Crna

## Okruženje

Tretman zaštite	TC
Temperatura okoline za skladištenje	-40...70 °C
Temperatura okoline za rad uređaja	-25...55 °C
Kategorija prenapona	Klasa I conforming to IEC 536
Ip stepen zaštite	IP65 u skladu sa IEC 60529
Ik stepen zaštite	IK06 u skladu sa IEC 60529
Standardi	GB 14048.1 IEC 60947-1 GB 14048.5 IEC 60947-5-1
Sertifikacija proizvoda	TÜV TÜV-C UKCA
Otpornost na vibracije	5 gn (f= 2...500 Hz) conforming to IEC 60068-2-6
Otpornost na udare	50 gn (trajanje = 11 milisekundi) za ubrzanje polovine sinusne periode u skladu sa IEC 60068-2-27 30 gn (trajanje = 18 milisekundi) za ubrzanje polovine sinusne periode u skladu sa IEC 60068-2-27

## Pakovanje

Unit Type of Package 1	PCE
Number of Units in Package 1	1
Package 1 Height	7 cm
Package 1 Width	3 cm
Package 1 Length	4,3 cm
Package 1 Weight	55 g
Unit Type of Package 2	BB1
Number of Units in Package 2	5
Package 2 Height	3 cm
Package 2 Width	12 cm
Package 2 Length	60 cm
Package 2 Weight	280 g
Unit Type of Package 3	S02
Number of Units in Package 3	100
Package 3 Height	15 cm
Package 3 Width	30 cm

---

Package 3 Length	40 cm
------------------	-------

---

Package 3 Weight	6,05 kg
------------------	---------

## Ugovorna garancija

---

Garancija (u mesecima)	18
------------------------	----

Schneider Electric namerava da postigne nulti status do 2050. godine kroz partnerstva sa lancem snabdevanja, materijale sa manjim uticajem i cirkularnost kroz našu tekuću kampanju "Use Better, Use Longer, Use Again" za produženje životnog veka proizvoda i reciklaže.

[Objašnjeni Environmental Data >](#)

[Kako procenjujemo održivost proizvoda >](#)

### Ekološki otisak

Ukupan životni vek ugljeničnog otiska	0.7 kg CO2 eq.
Ugljenični otisak faze proizvodnje [A1–A3]	0.4 kg CO2 eq.
Ugljenični otisak faze distribucije [A4]	0 kg CO2 eq.
Ugljenični otisak faze instalacije [A5]	0 kg CO2 eq.
Ugljenični otisak faze korišćenja [B2, B3, B4, B6]	0.2 kg CO2 eq.
Ugljenični otisak faze kraja životnog ciklusa [C1–C4]	0.1 kg CO2 eq.
Izjava o zaštiti okoliša	<a href="#">Profil ekološke prihvatljivosti proizvoda</a>

### Use Better

#### Materijali i pakovanje

Pakovanje sa recikliranim kartonom	Da
Pakovanje bez plastike	Ne
Direktiva RoHS	<a href="#">Usaglašeno</a>
Uredba REACH	<a href="#">Referenca ne sadrži SVHC iznad propisanog praga</a>

### Use Longer

#### Produženje trajanja veka

Popravka	Ne
----------	----

### Use Again

#### Prepakovanje i prefabrikovanje

Potencijal za recikliranje, u %	26
Profil cirkularnosti	<a href="#">Informacije o kraju radnog veka</a>
Povraćaj	No

Dimensions Drawings

Dimensions

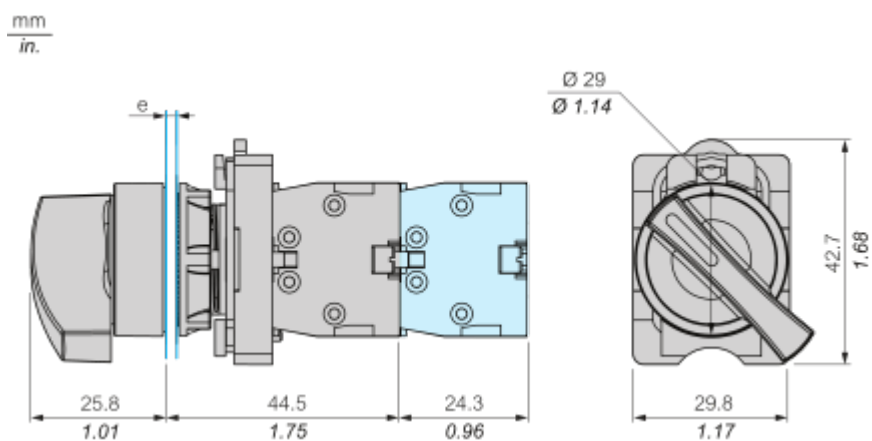

e : Clamping thickness : 1 to 5 mm/0.04 to 0.20 in.

Head Dimension

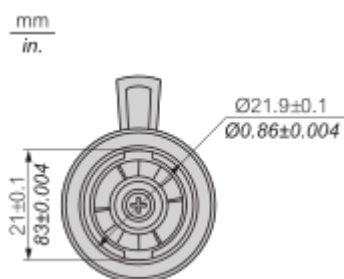

Mounting and Clearance

Panel Cut-Out

---





## Connections and Schema

### Wiring Diagram

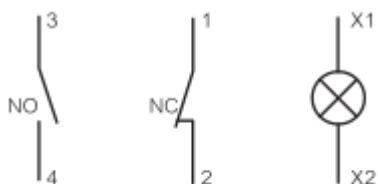
---



		
8.0 mm	0.5...2.5 mm <sup>2</sup>	0.5...1.5 mm <sup>2</sup>
0.32 in.	20...14 AWG	20...16 AWG

Wiring tightening torque : 0.8 ... 1.2 Nm (7 ... 10.6 lb-in)

Technical Illustration

Dimensions

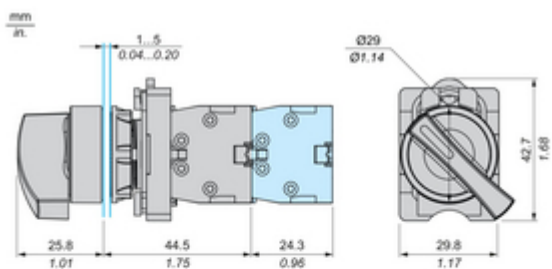

Head Dimension

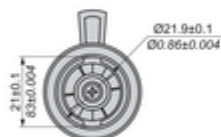

Panel Cut-Out

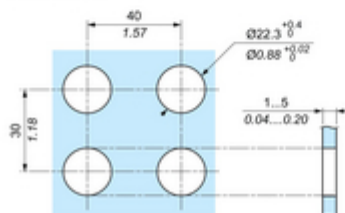

Technical Illustration

Wiring diagram



8.0 mm 0.32 in.	0.5...2.5 mm <sup>2</sup> 20...14 AWG	0.5...1.5 mm <sup>2</sup> 20...16 AWG

		Nm	0.8...1.2
		lb-in	7...10.6

Offer Marketing Illustration

Product benefits / Features

---

## 22 mm plastic pushbuttons and switches

Easy Harmony XA2



Easy installation  
and connection



Product  
robustness



Robust design for  
harsh environments



Ease and comfort of  
product selection



Wide  
availability



Groomed  
ergonomics



Offer Marketing Illustration

Product benefits / Features

---

## Technical Features

### Easy Harmony XA2



Offer Marketing Illustration

Product benefits / Features

---



The infographic features a central image of a black and silver pushbutton switch. Surrounding this central image are five circular icons, each with a corresponding text block describing a feature. The background is a solid green color.

### Features

#### Easy Harmony XA2

- Cost effective plastic pushbuttons with metallic-look ring** (Icon: Piggy bank)
- Full function solution fit to customer needs** (Icon: Key)
- Modular design allows flexible and simple setup for complete products** (Icon: Wrench and screwdriver)
- Strong robustness and harsh environment protection** (Icon: Snowflake and lightning bolt)
- Wide availability throughout an extensive distribution network** (Icon: Globe)

Image of product / Alternate images

Alternative

---





